

# RVQ5221

TOPMOUNT OUTDOOR SINK

**RUVATI**<sup>®</sup>  
SPECIFICATION SHEET

## MATERIAL

True 16 Gauge Thickness  
Marine Grade T316 Stainless Steel  
18/10 Chromium/Nickel Content  
Commercial Brushed Finish

## FEATURES

- Heavy duty sound guard padding and undercoating
- Slanted bottom with elegant drain grooves for easy draining
- Single-Tier Ledge for Accessories



## IN THE BOX

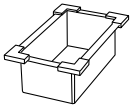

Colander  
[RVA1310]



Cutting Board  
[RVA1221BLK]

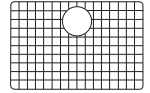

Rinse Grid  
[RVA68221]



Basket Strainer  
[RVA1025]

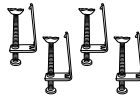

Mounting Clips  
[RVA11042]



Cut-out  
Template

## NOMINAL DIMENSIONS

Exterior: 21" (wide) x 20" (front-to-back)  
Interior Bowl: 19" (wide) x 14-5/8" (front-to-back)  
Bowl Depth: 9-1/2"  
Minimum Cabinet Size: 24" wide  
Drain Hole Size: 3-1/2"

Installation Type:  
Topmount

Inside Corners:  
Zero Radius

Drain Location:  
Rear Center

**RUVATI USA**

www.ruvati.com

Phone: 1.855.478.8284  
Email: support@ruvati.com

# OPTIONAL ACCESSORIES (SOLD SEPARATELY)



Deep Basket  
Disposal Flange  
[RVA1049ST]

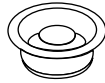

Garbage  
Disposal Flange  
[RVA1041ST]

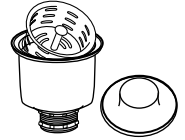

Deep Basket Strainer  
and Stopper  
[RVA1027ST]



Lid  
[RVA11621ST]



Deep Basket  
Disposal Flange/Stopper  
[RVA1052ST]

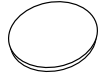

Drain Cover  
[RVA1035]

## DIMENSIONS

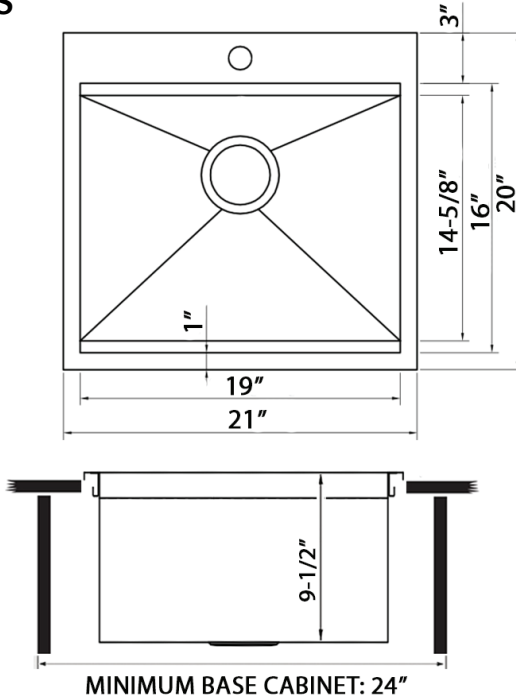

cUPC certified by IAPMO  
to meet US and Canada  
plumbing standards.



**SCAN TO REGISTER  
YOUR WARRANTY**

or visit  
[ruvati.com/register](http://ruvati.com/register)

**RUVATI USA**  
[www.ruvati.com](http://www.ruvati.com)

Phone: 1.855.478.8284  
Email: [support@ruvati.com](mailto:support@ruvati.com)