

RVQ5215

OUTDOOR BBQ SINK

RUVATI®

SPECIFICATION SHEET

MATERIAL

True 16 Gauge Thickness
Marine Grade T316 Stainless Steel
18/10 Chromium/Nickel Content
Commercial Brushed Finish

FEATURES

- Heavy duty sound guard padding and undercoating
- Slanted bottom with elegant drain grooves for easy draining
- Single-Tier Ledge for Accessories

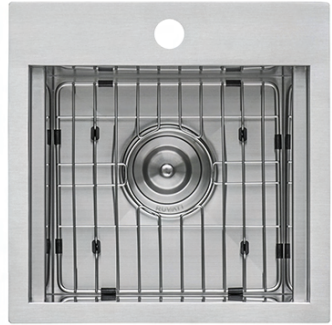

IN THE BOX

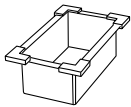

Colander
[RVA1315]



Cutting Board
[RVA1215BLK]

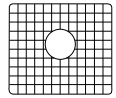

Rinse Grid
[RVA68215]



Basket Strainer
[RVA1025]

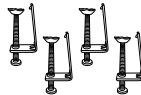

Mounting Clips
[RVA11042]



Cut-out
Template

NOMINAL DIMENSIONS

Exterior: 15" (wide) x 15" (front-to-back)
Interior Bowl: 11-5/8" (wide) x 11" (front-to-back)
Bowl Depth: 9"
Minimum Cabinet Size: 18" wide
Drain Hole Size: 3-1/2"

Installation Type:
Topmount
Inside Corners:
Zero Radius
Drain Location:
Center

RUVATI USA

www.ruvati.com

Phone: 1.855.478.8284
Email: support@ruvati.com

OPTIONAL ACCESSORIES (SOLD SEPARATELY)



Deep Basket
Disposal Flange
[RVA1049ST]

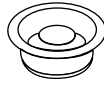

Garbage
Disposal Flange
[RVA1041ST]

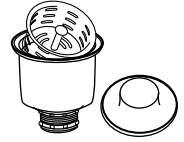

Deep Basket Strainer
and Stopper
[RVA1027ST]



Lid
[RVA11615ST]



Deep Basket
Disposal Flange/Stopper
[RVA1052ST]

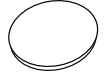

Drain Cover
[RVA1035]

DIMENSIONS

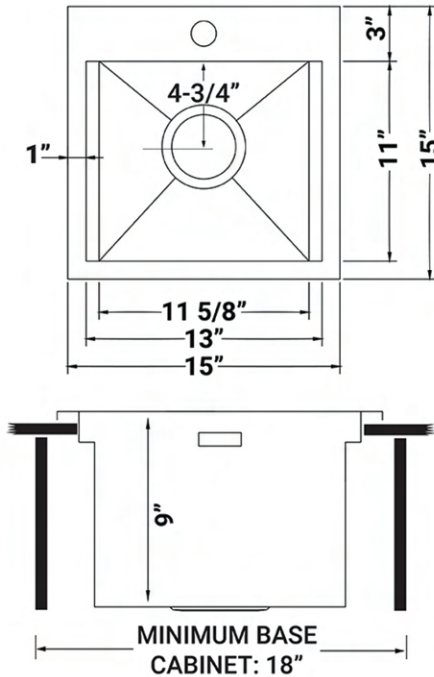

cUPC certified by IAPMO
to meet US and Canada
plumbing standards.



**SCAN TO REGISTER
YOUR WARRANTY**

or visit
ruvati.com/register

RUVATI USA
www.ruvati.com

Phone: 1.855.478.8284
Email: support@ruvati.com