

RVL2387

FIRECLAY FARMHOUSE SINK

RUVATI[®]
SPECIFICATION SHEET

MATERIAL

- True Italian Fireclay - Made in ITALY.
- 1-inch thick solid fireclay.
- Fired at 2900F for extreme strength.

FEATURES

- Large deep bowl.
- Rounded inside corners.
- Glossy enamel surface resistant to stains and scratches.

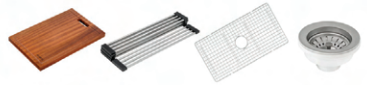

COLOR OPTIONS

BK: Glossy Black

WH: White

BS: Biscuit

EG: Emerald Green

IN THE BOX

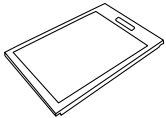

Cutting Board
[RVA1217]

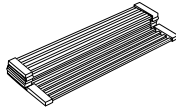

Folding Rack
[RVA1395]



Basket Strainer
[RVA1039ST]

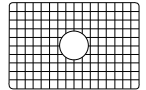

Rinse Grid
[RVA62387]

NOMINAL DIMENSIONS

Exterior: 33" (wide) x 18³/₈" (front-to-back)
Interior Bowl: 31" (wide) x 16" (front-to-back)
Bowl Depth: 9"
Minimum Cabinet Size: 36" wide
Drain Hole Size: 3¹/₂"

Installation Type:
Farmhouse
Inside Corners:
Rounded
Drain Location:
Center

RUVATI USA

www.ruvati.com

Phone: 1.855.478.8284
Email: support@ruvati.com

OPTIONAL ACCESSORIES (SOLD SEPARATELY)

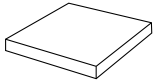

Butcher Block
[RVA2445ACA]

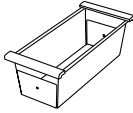

Colander
[RVA1317]

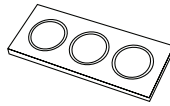

Condiment
Serving Tray
[RVA1377]

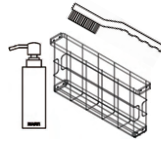

Caddy
[RVA1580]

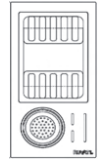

Caddy Drying Rack
[RVA1542BWC]

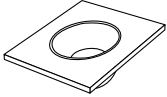

Mixing Bowl
and Platform
[RVA1288]



Deep Basket
Disposal Flange/Stopper
[RVA1052ST]



Garbage Disposal
Flange/Stopper
[RVA1042ST]



Deep Basket Strainer
and Stopper
[RVA1027ST]

DIMENSIONS

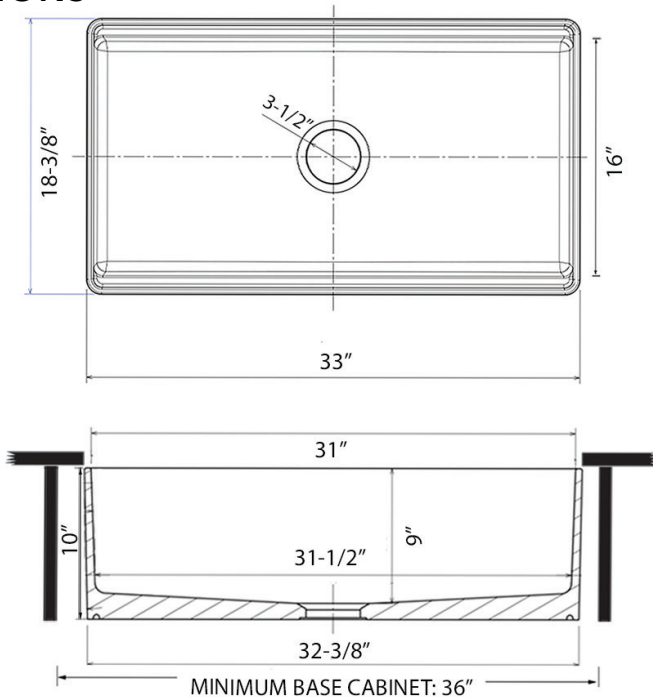

SCAN TO REGISTER YOUR WARRANTY

or visit
www.ruvati.com/register

RUVATI USA
www.ruvati.com

Phone: 1.855.478.8284
Email: support@ruvati.com