

# RVH9880

COLOR STAINLESS STEEL  
APRON-FRONT KITCHEN SINK

**RUVATI**<sup>®</sup>  
SPECIFICATION SHEET

## MATERIAL

- True 16 Gauge Thickness
- Premium T304 Grade Stainless Steel
- Nano-PVD colored finish: easy to clean, and long lasting

## FEATURES

- Heavy duty sound guard padding and undercoating
- Slanted bottom with elegant drain grooves for easy draining
- Rounded inside corners

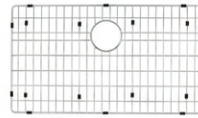

## COLOR OPTIONS

**BL:** Gunmetal Black

**CP:** Copper Tone Matte Bronze

**GG:** Matte Gold

## IN THE BOX



Basket Strainer  
[RVA1022BL / CP / GG]

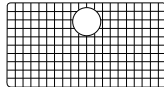

Rinse Grid  
[RVA69880]

## NOMINAL DIMENSIONS

Exterior: 36" (wide) x 22" (front-to-back)  
Interior Bowl: 34" (wide) x 18" (front-to-back)  
Bowl Depth: 9"  
Minimum Cabinet Size: 39" wide  
Drain Hole Size: 3½"

Installation Type:  
Apron-Front

Inside Corners:  
Rounded

Drain Location:  
Rear Center

**RUVATI USA**

www.ruvati.com

Phone: 1.855.478.8284  
Email: support@ruvati.com

# OPTIONAL ACCESSORIES (SOLD SEPARATELY)



Deep Basket  
Disposal Flange  
[RVA1049BL/GG]



Deep Basket  
Disposal Flange/Stopper  
[RVA1052BL/GG]



Garbage Disposal  
Flange/Stopper  
[RVA1042BL/GG]



Deep Basket Strainer  
and Stopper  
[RVA1027BL/GG]



Drain Cover  
[RVA1035]

## DIMENSIONS

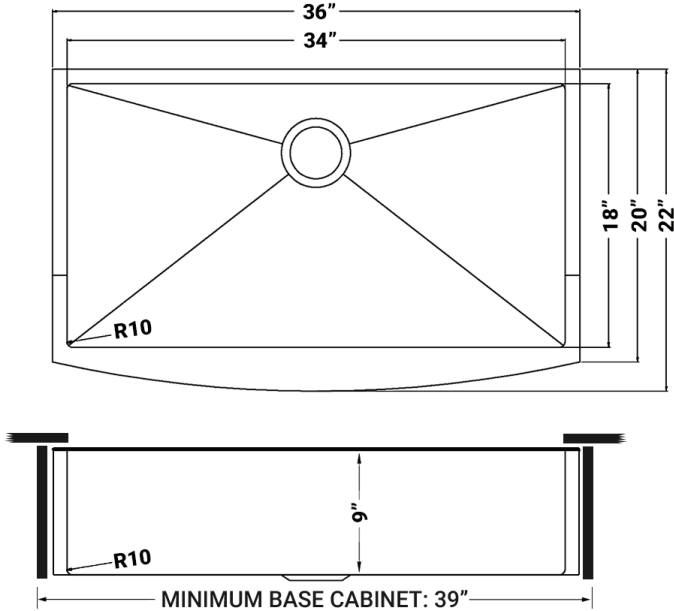

cUPC certified by IAPMO  
to meet US and Canada  
plumbing standards.



**SCAN TO REGISTER  
YOUR WARRANTY**

or visit  
[ruvati.com/register](http://ruvati.com/register)

**RUVATI USA**  
[www.ruvati.com](http://www.ruvati.com)

Phone: 1.855.478.8284  
Email: [support@ruvati.com](mailto:support@ruvati.com)