

# RVH9301

APRON-FRONT WORKSTATION SINK

**RUVATI**<sup>®</sup>  
SPECIFICATION SHEET

## MATERIAL

True 16 Gauge Thickness  
Premium T304 Grade Stainless Steel  
18/10 Chromium/Nickel Content  
Commercial Brushed Finish



## FEATURES

- Heavy duty sound guard padding and undercoating
- Slanted bottom with elegant drain grooves for easy draining
- Single-Tier Ledge for Accessories

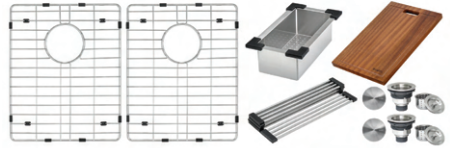

## IN THE BOX

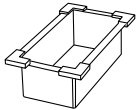

Colander  
[RVA1327]

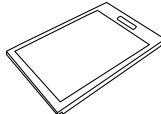

Cutting Board  
[RVA1217]

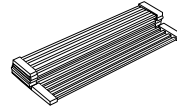

Folding Rack  
[RVA1395]



Basket Strainer  
[RVA1025] x 2

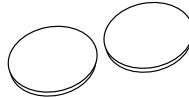

Drain Cover  
[RVA1035] x 2

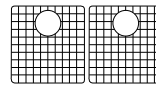

Rinse Grid  
[RVA69301]

## NOMINAL DIMENSIONS

**Exterior:** 36" (wide) x 22" (front-to-back)  
**Interior Bowl:** 16" x 16" (left) , 16" x 16" (right)  
**Bowl Depth:** 10" | **Front Apron Height:** 9"  
**Minimum Cabinet Size:** 39" wide  
**Drain Hole Size:** 3½"

## Installation Type:

Apron-Front

## Inside Corners:

Rounded

## Drain Location:

Rear Center

**RUVATI USA**

www.ruvati.com

Phone: 1.855.478.8284  
Email: support@ruvati.com

# OPTIONAL ACCESSORIES (SOLD SEPARATELY)

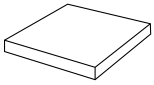

Butcher Block  
[RVA2445ACA]

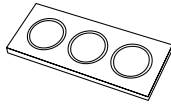

Condiment  
Serving Tray  
[RVA1377]



Caddy  
[RVA1580]

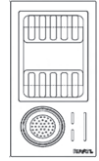

Caddy Drying Rack  
[RVA1542]

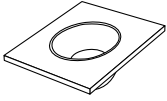

Mixing Bowl  
and Platform  
[RVA1288]



Deep Basket  
Disposal Flange/Stopper  
[RVA1052ST]



Garbage Disposal  
Flange/Stopper  
[RVA1042ST]



Deep Basket Strainer  
and Stopper  
[RVA1027ST]

## DIMENSIONS

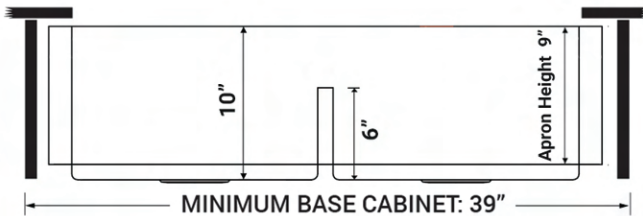
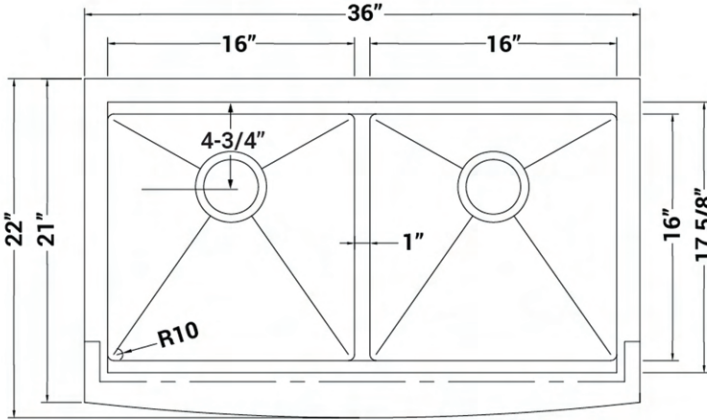

cUPC certified by IAPMO  
to meet US and Canada  
plumbing standards.



**SCAN TO REGISTER  
YOUR WARRANTY**

or visit  
[ruvati.com/register](http://ruvati.com/register)

# RUVATI USA

[www.ruvati.com](http://www.ruvati.com)

Phone: 1.855.478.8284  
Email: [support@ruvati.com](mailto:support@ruvati.com)