

RVH9201

APRON-FRONT WORKSTATION SINK

RUVATI[®]
SPECIFICATION SHEET

MATERIAL

True 16 Gauge Thickness
Premium T304 Grade Stainless Steel
18/10 Chromium/Nickel Content
Commercial Brushed Finish

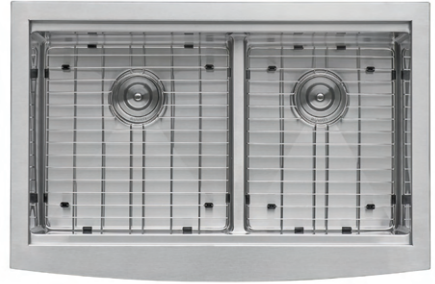

FEATURES

- Heavy duty sound guard padding and undercoating
- Slanted bottom with elegant drain grooves for easy draining
- Single-Tier Ledge for Accessories

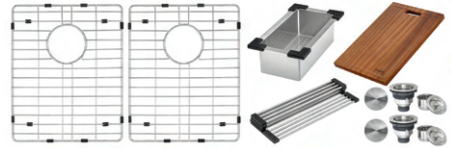

IN THE BOX

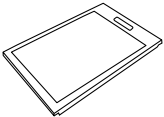

Cutting Board
[RVA1217]

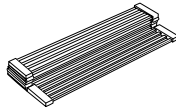

Folding Rack
[RVA1395]

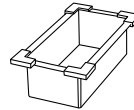

Colander
[RVA1327]



Basket Strainer
[RVA1025] x 2

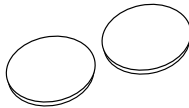

Drain Cover
[RVA1035] x 2

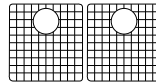

Rinse Grid
[RVA69201]

NOMINAL DIMENSIONS

Exterior: 33" (wide) x 22" (front-to-back)
Interior Bowl: 16" x 16" (left), 13" x 16" (right)
Bowl Depth: 10" | **Front Apron Height:** 9"
Minimum Cabinet Size: 36" wide
Drain Hole Size: 3½"

Installation Type:
Apron-Front
Inside Corners:
Rounded
Drain Location:
Rear Center

RUVATI USA

www.ruvati.com

Phone: 1.855.478.8284
Email: support@ruvati.com

OPTIONAL ACCESSORIES (SOLD SEPARATELY)

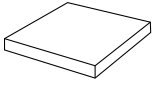

Butcher Block
[RVA2445ACA]

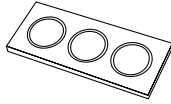

Condiment
Serving Tray
[RVA1377]



Caddy
[RVA1580]

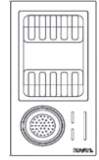

Caddy Drying Rack
[RVA1542]

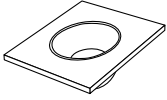

Mixing Bowl
and Platform
[RVA1288]



Deep Basket
Disposal Flange/Stopper
[RVA1052ST]



Garbage Disposal
Flange/Stopper
[RVA1042ST]



Deep Basket Strainer
and Stopper
[RVA1027ST]

DIMENSIONS

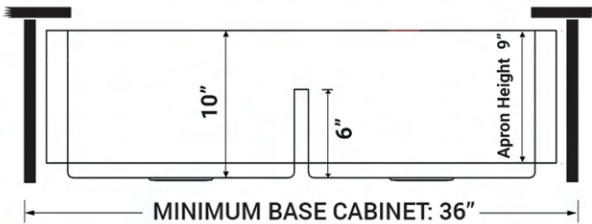
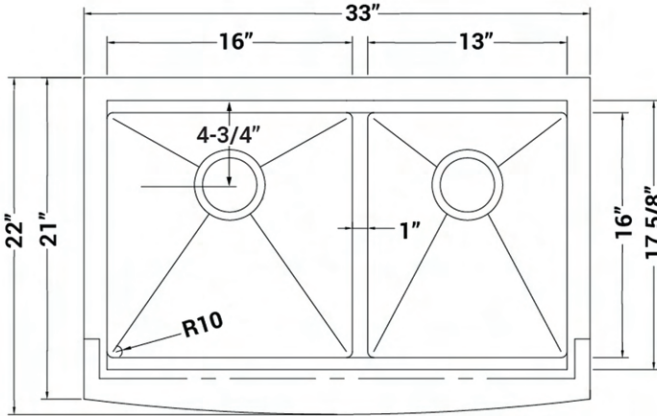

cUPC certified by IAPMO
to meet US and Canada
plumbing standards.



**SCAN TO REGISTER
YOUR WARRANTY**

or visit
ruvati.com/register

RUVATI USA

www.ruvati.com

Phone: 1.855.478.8284
Email: support@ruvati.com