

# RVH8570

UNDERMOUNT SLOPE BOTTOM SINK

**RUVATI**<sup>®</sup>  
SPECIFICATION SHEET

## MATERIAL

True 16 Gauge Thickness  
Premium T304 Grade Stainless Steel  
18/10 Chromium/Nickel Content  
Commercial Brushed Finish



## FEATURES

- Heavy duty sound guard padding and undercoating
- Slanted bottom with elegant drain grooves for easy draining
- Reversible Offset Drain with Sloped Bottom



## IN THE BOX

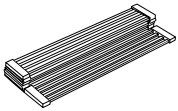

Folding Rack  
[RVA1395]

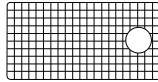

Rinse Grid  
[RVA68570]

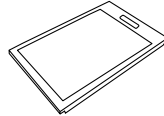

Cutting Board  
[RVA1217]

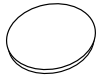

Drain Cover  
[RVA1035]



Basket Strainer  
[RVA1025]

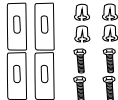

Mounting Clips  
[RVA11031]



Cut-out  
Template

## NOMINAL DIMENSIONS

**Exterior:** 27" (wide) x 19" (front-to-back)  
**Interior Bowl:** 25½" (wide) x 16" (front-to-back)  
**Bowl Depth:** 10"  
**Minimum Cabinet Size:** 30" wide  
**Drain Hole Size:** 3½"

**Installation Type:**  
Undermount  
**Inside Corners:**  
Rounded  
**Drain Location:**  
Offset

**RUVATI USA**

www.ruvati.com

Phone: 1.855.478.8284  
Email: support@ruvati.com

## OPTIONAL ACCESSORIES (SOLD SEPARATELY)

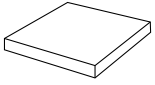

Butcher Block  
[RVA2445ACA]

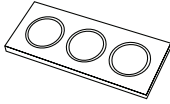

Condiment  
Serving Tray  
[RVA1377]

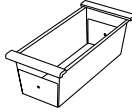

Colander  
[RVA1317]



Caddy  
[RVA1580]

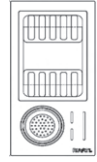

Caddy Drying Rack  
[RVA1542]

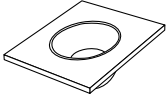

Mixing Bowl  
and Platform  
[RVA1288]



Deep Basket  
Disposal Flange/Stopper  
[RVA1052ST]



Garbage Disposal  
Flange/Stopper  
[RVA1042ST]



Deep Basket Strainer  
and Stopper  
[RVA1027ST]

## DIMENSIONS

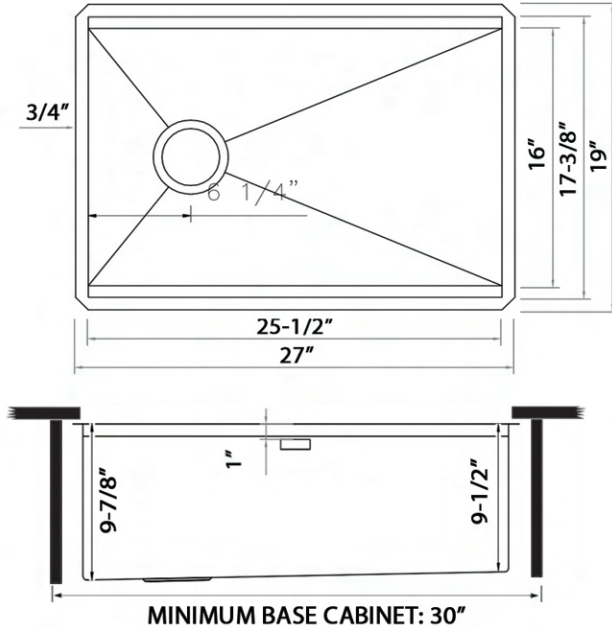

cUPC certified by IAPMO  
to meet US and Canada  
plumbing standards.



SCAN TO REGISTER  
YOUR WARRANTY

or visit  
[ruvati.com/register](http://ruvati.com/register)

# RUVATI USA

[www.ruvati.com](http://www.ruvati.com)

Phone: 1.855.478.8284  
Email: [support@ruvati.com](mailto:support@ruvati.com)