

RVH8542

UNDERMOUNT WORKSTATION BAR SINK

RUVATI®

SPECIFICATION SHEET

MATERIAL

True 16 Gauge Thickness
Premium T304 Grade Stainless Steel
18/10 Chromium/Nickel Content
Commercial Brushed Finish

FEATURES

- Heavy duty sound guard padding and undercoating
- Built-in glass rinser with drying rack
- Single-Tier Ledge for Accessories

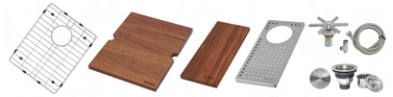

IN THE BOX



Basket Strainer
[RVA1025]

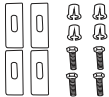

Mounting Clips
[RVA11031]



Flex Hose
[RVA11025]

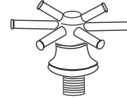

Sprayer Assembly
[RVA11026]

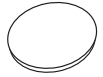

Drain Cover
[RVA1035]



Cut-out
Template

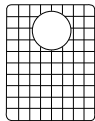

Rinse Grid
[RVA68210]

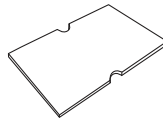

Cutting Board
[RVA1210]

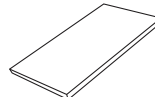

Cutting Board
[RVA1242]

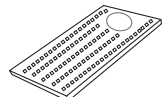

Drainer Grate
[RVA11027]

NOMINAL DIMENSIONS

Exterior: 22" (wide) x 18" (front-to-back)

Interior Bowl: 13" x 14 $\frac{5}{8}$ " (left), 7" x 14 $\frac{5}{8}$ " (right)

Bowl Depth: 10"

Minimum Cabinet Size: 24" wide

Drain Hole Size: 3 $\frac{1}{2}$ "

Installation Type:

Undermount

Inside Corners:

Sharp

Drain Location:

Rear Center

RUVATI USA

www.ruvati.com

Phone: 1.855.478.8284
Email: support@ruvati.com

OPTIONAL ACCESSORIES (SOLD SEPARATELY)



Deep Basket
Disposal Flange
[RVA1049ST]



Deep Basket
Disposal Flange/Stopper
[RVA1052ST]



Garbage Disposal
Flange/Stopper
[RVA1042ST]



Deep Basket Strainer
and Stopper
[RVA1027ST]

DIMENSIONS

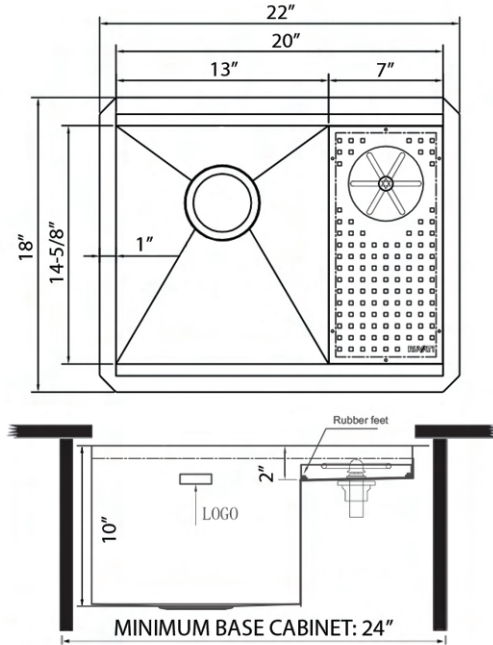

cUPC certified by IAPMO
to meet US and Canada
plumbing standards.



**SCAN TO REGISTER
YOUR WARRANTY**

or visit
ruvati.com/register

RUVATI USA
www.ruvati.com

Phone: 1.855.478.8284
Email: support@ruvati.com