

RVH8320

UNDERMOUNT WORKSTATION SINK

RUVATI[®]
SPECIFICATION SHEET

MATERIAL

True 16 Gauge Thickness
Premium T304 Grade Stainless Steel
18/10 Chromium/Nickel Content
Commercial Brushed Finish



FEATURES

- Heavy duty sound guard padding and undercoating
- Slanted bottom with elegant drain grooves for easy draining
- Single-Tier Ledge for Accessories



IN THE BOX

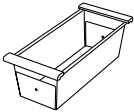

Colander
[RVA1317]

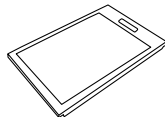

Cutting Board
[RVA1217]

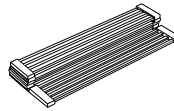

Folding Rack
[RVA1395]

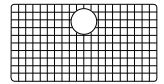

Rinse Grid
[RVA68310]



Basket Strainer
[RVA1025]



Drain Cover
[RVA1035]

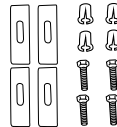

Mounting Clips
[RVA11031]



Cut-out
Template

NOMINAL DIMENSIONS

Exterior: 30" (wide) x 19" (front-to-back)
Interior Bowl: 28 $\frac{3}{8}$ " (wide) x 16" (front-to-back)
Bowl Depth: 10"
Minimum Cabinet Size: 33" wide
Drain Hole Size: 3 $\frac{1}{2}$ "

Installation Type:

Undermount

Inside Corners:

Rounded

Drain Location:

Rear Center

RUVATI USA

www.ruvati.com

Phone: 1.855.478.8284
Email: support@ruvati.com

OPTIONAL ACCESSORIES (SOLD SEPARATELY)

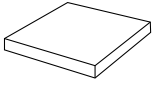

Butcher Block
[RVA2445ACA]

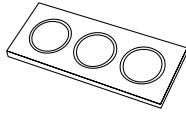

Condiment
Serving Tray
[RVA1377]



Caddy
[RVA1580]

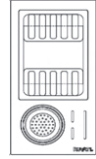

Caddy Drying Rack
[RVA1542]

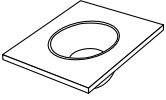

Mixing Bowl
and Platform
[RVA1288]



Deep Basket
Disposal Flange/Stopper
[RVA1052ST]



Garbage Disposal
Flange/Stopper
[RVA1042ST]



Deep Basket Strainer
and Stopper
[RVA1027ST]

DIMENSIONS

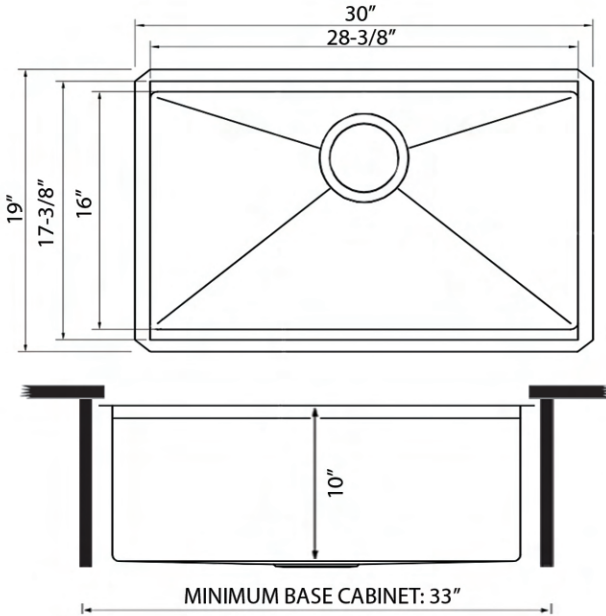

cUPC certified by IAPMO
to meet US and Canada
plumbing standards.



**SCAN TO REGISTER
YOUR WARRANTY**

or visit
ruvati.com/register

RUVATI USA

www.ruvati.com

Phone: 1.855.478.8284
Email: support@ruvati.com