

# RVH8003

TOPMOUNT WORKSTATION SINK

**RUVATI**<sup>®</sup>  
SPECIFICATION SHEET

## MATERIAL

- True 16 Gauge Thickness
- Premium T304 Grade Stainless Steel
- 18/10 Chromium/Nickel Content
- Commercial Brushed Finish

## FEATURES

- Heavy duty sound guard padding and undercoating
- Slanted bottom with elegant drain grooves for easy draining
- Single-Tier Ledge for Accessories



## IN THE BOX

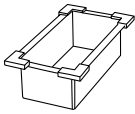

Colander  
[RVA1327]

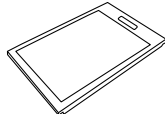

Cutting Board  
[RVA1217]

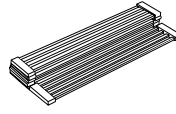

Folding Rack  
[RVA1395]

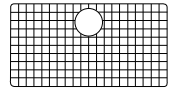

Rinse Grid  
[RVA68003]



Basket Strainer  
[RVA1025]



Drain Cover  
[RVA1035]



Mounting Clips  
[RVA11042]



Cut-out  
Template

## NOMINAL DIMENSIONS

- Exterior:** 33" (wide) x 22" (front-to-back)
- Interior Bowl:** 31" (wide) x 16" (front-to-back)
- Bowl Depth:** 10"
- Minimum Cabinet Size:** 36" wide
- Drain Hole Size:** 3½"

- Installation Type:** Topmount
- Inside Corners:** Rounded
- Drain Location:** Rear Center

**RUVATI USA**

www.ruvati.com

Phone: 1.855.478.8284  
Email: support@ruvati.com

# OPTIONAL ACCESSORIES (SOLD SEPARATELY)

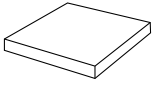

Butcher Block  
[RVA2445ACA]

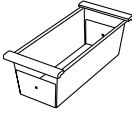

Colander  
[RVA1317]

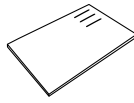

Cutting Board  
[RVA1217CR]



Caddy  
[RVA1580]



Caddy Drying Rack  
[RVA1542]

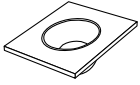

Mixing Bowl and Platform  
[RVA1288]

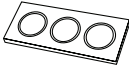

Condiment Serving Tray  
[RVA1377]



Deep Basket Disposal Flange/Stopper  
[RVA1052ST]



Garbage Disposal Flange/Stopper  
[RVA1042ST]



Deep Basket Strainer and Stopper  
[RVA1027ST]

## DIMENSIONS

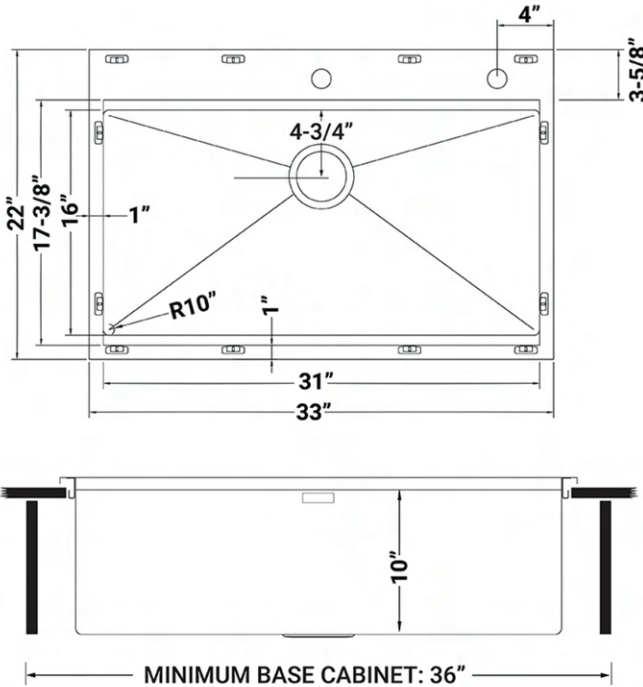

cUPC certified by IAPMO to meet US and Canada plumbing standards.



SCAN TO REGISTER YOUR WARRANTY

or visit [ruvati.com/register](http://ruvati.com/register)

# RUVATI USA

[www.ruvati.com](http://www.ruvati.com)

Phone: 1.855.478.8284  
Email: [support@ruvati.com](mailto:support@ruvati.com)