

RVH5003

TOPMOUNT WORKSTATION SINK

RUVATI[®]
SPECIFICATION SHEET

MATERIAL

True 16 Gauge Thickness
Premium T304 Grade Stainless Steel
Nano-PVD colored finish: easy to clean, and long lasting

FEATURES

- Heavy duty sound guard padding and undercoating
- Slanted bottom with elegant drain grooves for easy draining
- Rounded inside corners

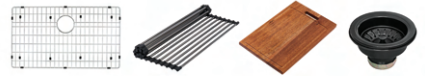

COLOR OPTIONS

BL: Black Stainless Steel

GG: Matte Gold Brass Tone

IN THE BOX

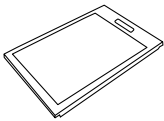

Cutting Board
[RVA1217AQ]

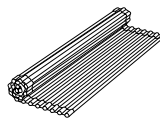

Rollup Rack
[RVA1385BL /GG]

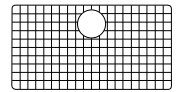

Rinse Grid
[RVA68003]



Basket Strainer
[RVA1022BL /GG]



Mounting Clips
[RVA11048]



Cut-out
Template

NOMINAL DIMENSIONS

Exterior: 33" (wide) x 22" (front-to-back)
Interior Bowl: 31" (wide) x 16" (front-to-back)
Bowl Depth: 9"
Minimum Cabinet Size: 36" wide
Drain Hole Size: 3½"

Installation Type:
Topmount

Inside Corners:
Rounded

Drain Location:
Rear Center

RUVATI USA

www.ruvati.com

Phone: 1.855.478.8284
Email: support@ruvati.com

OPTIONAL ACCESSORIES (SOLD SEPARATELY)

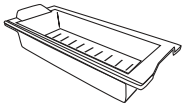

Colander
[RVA1367BLK]

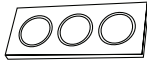

Condiment
Serving Tray
[RVA1377BWC]

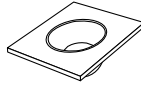

Mixing Bowl
and Platform
[RVA1288BWC]



Caddy
[RVA1580]

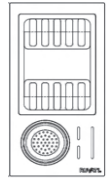

Drying Rack
[RVA1542BWC]

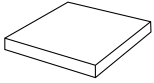

Butcher Block
[RVA2445ACA]

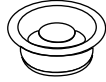

Garbage
Disposal Flange
[RVA1041BL/GG]

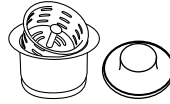

Deep Basket
Disposal Flange/Stopper
[RVA1052BL/GG]



Deep Basket Strainer
and Stopper
[RVA1027BL/GG]

DIMENSIONS

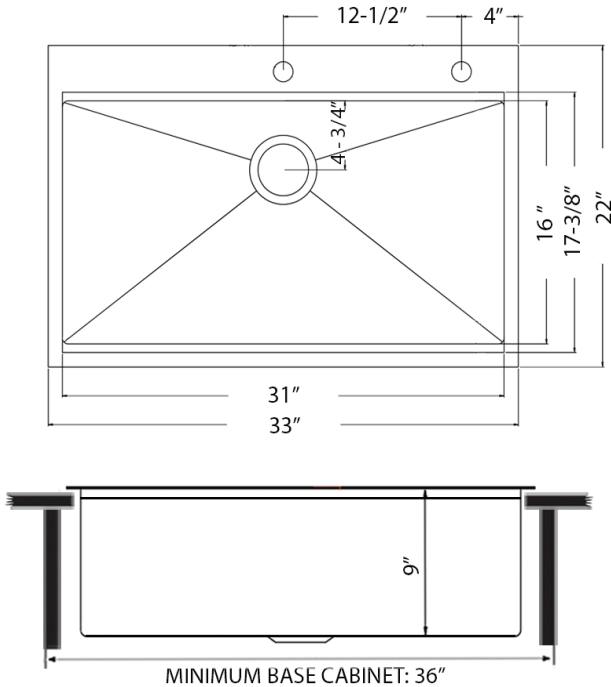

cUPC certified by IAPMO
to meet US and Canada
plumbing standards.



**SCAN TO REGISTER
YOUR WARRANTY**

or visit
ruvati.com/register

RUVATI USA
www.ruvati.com

Phone: 1.855.478.8284
Email: support@ruvati.com